

## III-3-1 Network infrastructure development

### (1) Promoting construction of nationwide fiber-optic networks

Construction of a nationwide fiber-optic network is progressing smoothly towards completion in 2005.

Fiber-optic networks facilitate new services to be offered, such as electronic commerce and telemedicine, because they can transmit broadband data at much higher speeds than conventional coaxial cables, while causing almost no deterioration or losses in transmission. As such, they are essential infrastructure for advanced info-communications systems.

The May 1994 report from the Telecommunications Council, "Reforms toward the Intellectually Creative Society of the 21st Century," gave the time of completing Japan's nationwide fiber-optic networks as 2010. However, in November 1997, a ministerial meeting on economic issues reached the conclusion that "further efforts should be made to complete the nationwide fiber-optic networks as early as possible capitalizing on private-sector participation to complete the networks as early as the year 2005."

MPT has been extending financial support to carriers since fiscal 1995 through the "Special Financing System for the Development of the Subscriber Optical Fiber Network" (Table), with the aim of easing their financial burden in building subscriber fiber-optic loops, which are still underdeveloped compared to trunk lines. In this system, a fund was established by the TAO to subsidize part of interests on NTT-C' loans admitted for the purpose of subscriber fiber-optic network construction. The difference between the NTT-C' loan interest rate and the minimum interest rate (in the first five years, 2%; and after that, 2.5%) is covered by the fund (Refer to Appendix 34).

As a result of these efforts, development of fiber-optic networks is progressing smoothly, and by the end of fiscal 1998, they had been installed in approximately 27% of the country (Fig.).

Table Special Financing System for Development of Subscriber Optical Fiber Networks

(Unit: 1 billion yen)

Fiscal year	1995 (1st fiscal year)	1996	1997	1998	1999
Special loan limit	30.0	42.0	51.1	66.6	72.5

Fig. Schedule for completion of nationwide fiber-optic networks

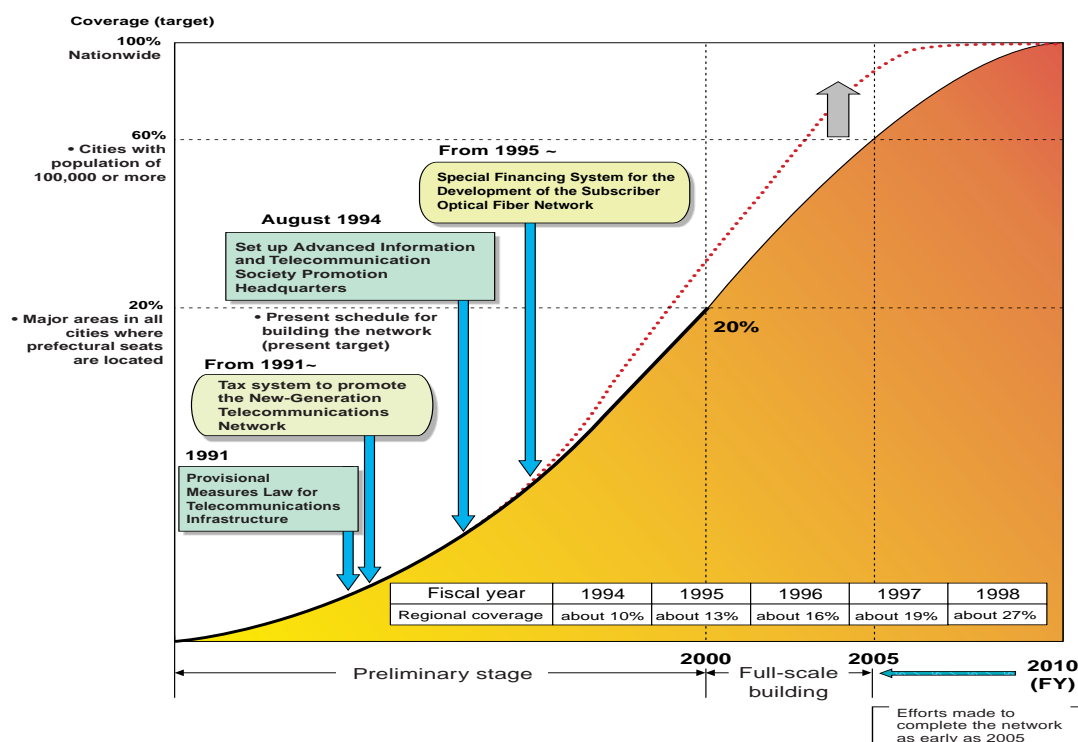

## (2) Introduction of new fixed wireless access system

**Regional communications markets are to be revitalized through introduction of a next-generation fixed wireless access system.**

A new fixed wireless access system that can transmit bulk data has been gaining much attention. The system directly connects telecommunications carriers' line facilities with businesses or homes, using quasi-millimeter and millimeter waves (the 22 GHz, 26 GHz and 38 GHz bands). If put into practice, it will allow networks to be built at low cost, slashing the financial burden on carriers in enter-

ing a regional communications market. Therefore, expectations are high that the system will promote further competition in Japan's regional markets, which are still dominated by NTT.

In December 1998, MPT promulgated ministerial ordinances pertaining to this system, and released guidelines on its introduction.

**Fig. Fixed wireless access system using quasi-millimeter and millimeter waves**

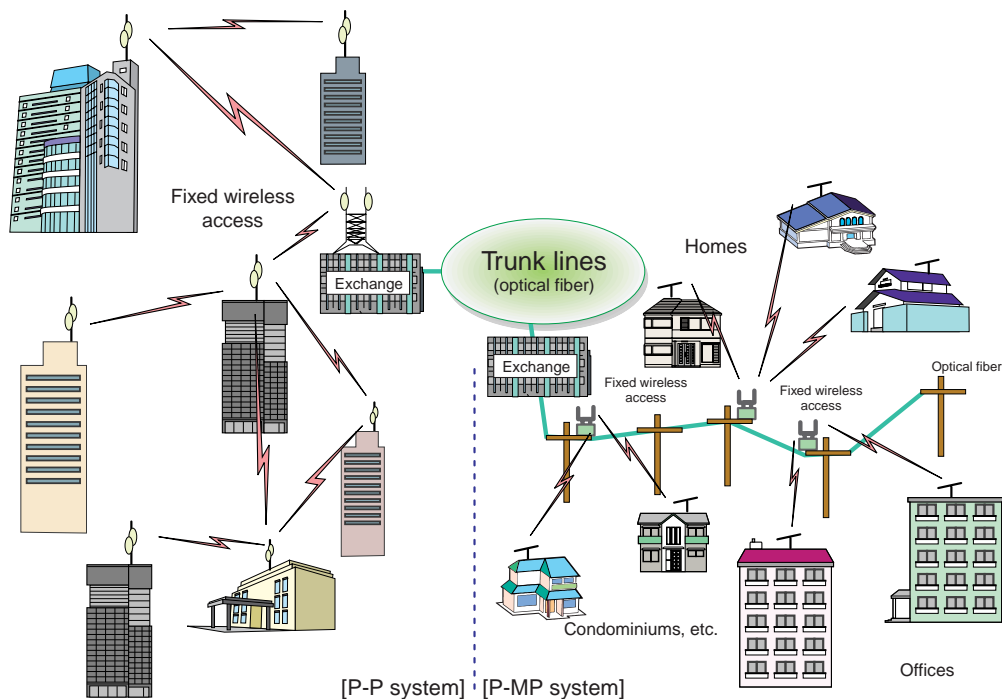

**Table Specifications of fixed wireless access system using quasi-millimeter and millimeter waves**

	P-P system (mainly for corporate users)		P-MP system (mainly for residential users)	
Frequency band	22-GHz, 26-GHz and 38-GHz		26-GHz and 38-GHz	
Communications method	Duplex	FDD	FDD or TDD	
	Access	--	FDMA or TDMA	
Modulation	4 PSK, 4 FSK or 16QAM or higher		GMSK, 4 PSK or 16QAM or higher	
Aerial RF power	not more than 0.5 W		not more than 0.5 W (for reference)	
Transmission capacity	not more than 156 Mbps (for reference)		not more than about 10 Mbps (for reference)	
Transmission distance	max. 4km (for reference)		within a radius of 1 km (for reference)	

- Notes:**
1. P-P (Point to Point) system is suitable for large corporate users because it can handle large capacity communications.
  2. P-MP (Point to Multipoint) system is suitable for homes and SOHOs, which deal with relatively small amount of information.

### (3) Promotion of the Third-generation Mobile Communications System “IMT-2000”

In March 1999, the ITU approved key characteristics of the radio interfaces for IMT-2000.

By the third-generation mobile communications system, IMT-2000, the same phone can provide high-speed, clear, mobile communications anywhere in the world. To implement this system by 2001, the International Telecommunication Union (ITU) is proceeding with standardization work on radio interfaces and network technologies.

For the radio interfaces, most countries have adopted CDMA (Code Division Multiple Access) as the base system, and Japan proposed its W (Wideband)-CDMA, similar to the European one, to the ITU. Meanwhile, the U.S. proposed a system called cdma2000, which differs from W-CDMA in detailed parameters. After long study, a March 1999 meeting of the ITU-R TG 8/1, convened in Brazil, adopted a Recommendation on key characteristics for the radio interfaces of IMT-2000, which includes all the interfaces proposed by ITU member countries. The work will be continued at ITU-R TG 8/1, so as to be able to integrate CDMA and TDMA into single standard of the IMT-2000 radio interfaces. The group will compile a new Recommendation stipulating detailed specifications upon com-

pleting its standardization work.

IMT-2000 network technologies are also under study toward standardization. At its March 1999 meeting, the relevant Study Group in the ITU's Telecommunications Sector (ITU-T SG 11) adopted a Recommendation pertaining to the framework and function models of the IMT-2000 network. SG 11 will continue its study on the technologies necessary for making IMT-2000 a truly global service, and plans to complete its standardization work by early 2000.

Japan as well will establish necessary domestic standards in line with the ITU decisions on IMT-2000 technologies. The technical requirements for radio equipment for the third-generation mobile communications systems will be determined, based on the parameters adopted by the ITU, such as the transmission mode and chip rate. After completing a list of such technical requirements, MPT will ask the Telecommunications Technology Council to study them and submit its findings as a report to MPT.

Table Features of IMT-2000

1. **High-speed (up to 2 Mbps, which enables rough video streaming)**  
Reference: The most common transmission speeds in the status quo are about 9.6 kbps with cellular telephones and 32 to 64 kbps with PHS terminals.
2. **A global service available at anywhere in the world**
3. **Highly reliable communications system, comparable with fixed networks**

Fig. Outline of IMT-2000

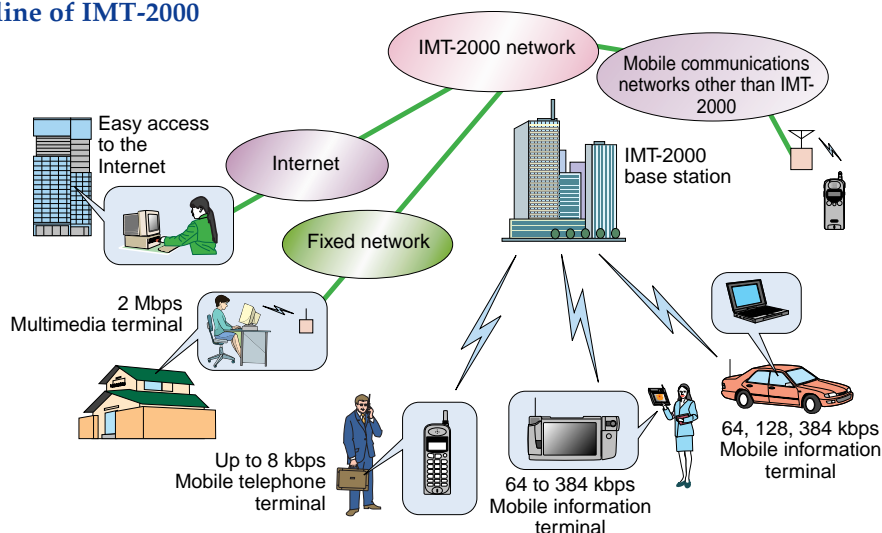

## (4) Narrowing gaps in access to information

### Projects are under way to ensure equal access to info-communications infrastructure throughout Japan.

Since fiscal 1991, MPT has been conducting a range of projects for ensuring equal access to telecommunications and broadcasting throughout Japan. The aim is to narrow the growing gap in access to info-communications between urban centers and rural areas, where access is limited because of topographical features and other factors (Table, Fig. and refer to Appendices 36 to 40). Since fiscal 1990, MPT has also been conducting the "Project to support the construction of satellite broadcasting receiving facilities," to provide residents who do not have clear reception of NHK terrestrial TV pro-

gramming with a means of viewing them through satellite broadcasting channels.

In addition, MPT had been promoting projects to eliminate poor reception of commercial terrestrial TV broadcasting in areas where no commercial channel could be viewed clearly. However, in fiscal 1998 this effort was widened to include areas where commercial broadcasts from within the same prefecture can be viewed well, but not nationwide broadcasting nor broadcasting covering several prefectures.

Table Projects for ensuring equal access to info-communications infrastructure

Project name	Details	Targeted area and party	Promoter	Government subsidy
Project for construction of transmission towers for mobile communications (Since fiscal 1991)	Construction of facilities to enable use of cellular/car telephones 1) Transmission towers for mobile communications 2) Radio facilities inside highway tunnels (Since fiscal 1994) and underground radio facilities (Since fiscal 1993)	Places where cellular/car phones cannot be used 1) Thinly populated areas, remote islands and peninsulas, villages and farms in mountainous areas, and areas with heavy snowfall 2) Inside highway tunnels, underground shopping streets and car parks Cumulative number of projects: 302; During fiscal 1998: 138 projects	1) Cities/ towns/ villages  2) Non-profit organizations	1) 1/3  2) 1/4
Project for eliminating poor reception of commercial terrestrial TV broadcasting (Since fiscal 1991)	Construction of the following facilities to eliminate poor reception areas of commercial terrestrial TV broadcasting 1) Relay stations 2) Shared-use reception facilities	Areas where no commercial terrestrial TV broadcasting cannot be viewed clearly 1) a) Sparsely populated areas b) Other areas 2) a) Sparsely populated areas b) Other areas Cumulative number of projects: 505 (in 291 areas); During fiscal 1998: 68 projects (in 50 areas)	1) a) Cities/ towns/ villages b) Non-profit organizations 2) a) Cities/ towns/ villages b) Cities/ towns/ villages or non-profit organizations	1) a) 1/3 b) 1/4 2) a) 1/3 b) 1/3
Project for eliminating poor reception of commercial AM radio broadcasting (Since fiscal 1992)	Construction of relay stations for eliminating poor reception of commercial AM radio broadcasting	Areas where commercial AM radio broadcasting cannot be received clearly due to interference by radio waves from radio stations overseas, or due to such topographical features as mountains Cumulative number of projects: 23 (in 35 areas); During fiscal 1998: 1 project (in 1 area)	1) Cities/ towns/ villages (Since fiscal 1993) 2) Non-profit organizations	1) 1/3 2) 1/4
Project for eliminating poor reception in urban centers (Since fiscal 1993)	Construction of shared-use receiving facilities for eliminating poor reception of commercial terrestrial TV broadcasting	Densely built areas where it is very difficult to identify the buildings blocking radiowaves Cumulative number of projects: 7 (in 2 areas); During fiscal 1998: 1 project (in 1 area)	Cities/ towns/ villages or special districts	1/3
Project to support construction of satellite broadcasting receiving facilities (since fiscal 1990)	Construction of NHK satellite broadcasting receiving facilities to provide residents with a means of viewing NHK terrestrial TV broadcasting (Projects must be approved by either the prefecture or city/town/village, which must subsidize 25% of the total cost, equal to the central government subsidy.)	Residents in areas where NHK terrestrial TV broadcasting cannot be received clearly due to topographical features (except for buildings) Cumulative number of projects: about 20,000 households (in 236 cities/towns/villages); During fiscal 1998: about 2,000 households (in 48 cities/towns/villages)	Individuals or groups of people	1/4

Fig. Total number of projects carried out and households benefiting from them (cumulative figures)

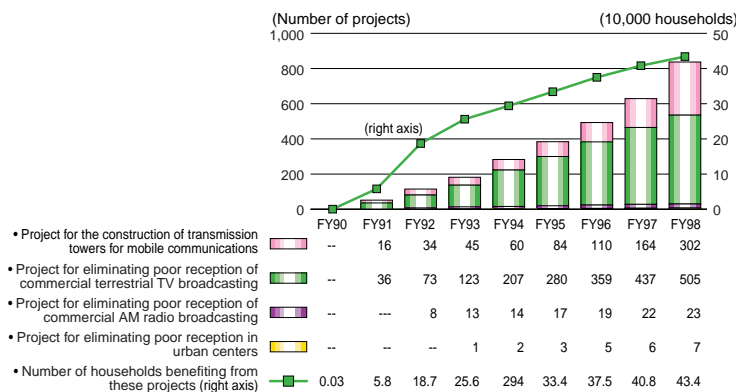

Note: The "number of households benefiting from these projects" shows the sum of the households enabled to receive TV and radio broadcasting clearly through the project for eliminating poor reception areas of commercial terrestrial TV broadcasting, the project for eliminating poor reception areas of commercial AM radio, the project for eliminating poor reception areas in urban centers, and the project for supporting the construction of satellite broadcasting receiving facilities.





## (2) Computer Year 2000 (Y2K) Problem

Measures to deal with the Y2K problem are being taken by ministries and agencies, as well as by the info-communications industry.

On January 1, 2000, in computer programs that record years with only the last two digits, it is possible that computers and microchips will recognize "00" not as the year 2000, but as the year 1900. This is the so-called Y2K problem, and it could cause serious effects in every field of socioeconomic activities in today's highly computer-dependent world.

In April 1999, the Japanese government convened the "Y2K Advisors' Conference" to find out how far measures were being taken against it. Establishment of the conference had been planned in the "Y2K Action Plan," adopted in September 1998 by the Advanced Information and Telecommunication Society Promotion Headquarters.

Of the computer systems installed at ministries, agencies and special public organizations, those that could have a major effect on corporate activities and people's day-to-day lives have been subject to the preparations shown in Table 1. By June 1999, 92% of these targeted systems is expected to

complete test runs, except for some cases where hardware was due to be replaced before the end of the year.

For its part, MPT organized "Contact Meetings on the Y2K Issue in Telecommunications" in October 1998 to widely address the problem and to ask businesses in the telecommunications industry to voluntarily carry out comprehensive tests on their own systems. In addition, MPT organized a Y2K check system, comprising experts who will proceed with countermeasures in an open and fair manner.

In March 1999, MPT also established "Contact Meeting on Y2K Issues in Broadcasting," which consists of industry organizations, NHK and others. MPT has been calling for further information exchange among these bodies and additional measures to successfully deal with the Y2K problem.

MPT will strive to implement its Y2K policy measures as quickly as possible, while well directing action by businesses in the telecommunications and broadcasting industries (Table 2).

III-3

**Table 1. Preparation for Y2K at ministries, agencies and special public organizations (except for medical institutions)**

(As of March 1999)

Step	As of March 1, 1999	As of June 30, 1999 (Estimate)
Reprogramming completed	67%	92%
Test-runs successful	45%	92%
Emergency manuals ready	9%	77%

Source: Management and Coordination Agency

**Table 2. Preparation for Y2K in info-communications sector**

[System updates on important telecommunications networks]

(As of March 1999)

Step		March 31, 1999	June 30, 1999	Sept. 30, 1999 (estimate)
Telephone/ leased circuit systems	Reprogramming completed	91%	100%	100%
	Test-runs successful	69%	99%	100%
Mobile telephone systems	Reprogramming completed	80%	98%	100%
	Test-runs successful	74%	97%	100%

Note: In totaling percentages obtained from the companies surveyed, these percentages were recalculated in proportion to each company's business size.

[System updates on important broadcasting equipment]

Step	Oct. 30, 1998	March 31, 1999	June 30, 1999	Sept. 30, 1999 (estimate)
Test-runs successful	47%	53%	67%	86%

Source: MPT

Related site: Y2K Action Plan (<http://www.kantei.go.jp/jp/pc2000/980911action.html>)

# III-3-3 Promotion of digital broadcasting

## (1) Promotion of digital broadcasting

Steady progress is being made in introducing digital broadcasting in Japan.

Around the world, more and more countries are introducing digital broadcasting, because it makes possible multichannel, high-resolution and multi-functional broadcasting, as well as the highly effective use of frequencies. In addition, using digital technology to raise the number of channels that can be broadcast encourages new entries into the broadcasting business, giving viewers a wider choice of programs and services. At the same time, broad-

casting services are enhanced through their convergence with computer networks.

MPT is striving to introduce digitalization to all broadcasting services (terrestrial, satellite and cable television) as soon as possible, in order to maintain Japan's international competitiveness in the broadcasting field and to bring the benefits of digital broadcasting to viewers, broadcasters and program producers.

Fig. 1 Outline of digital broadcasting

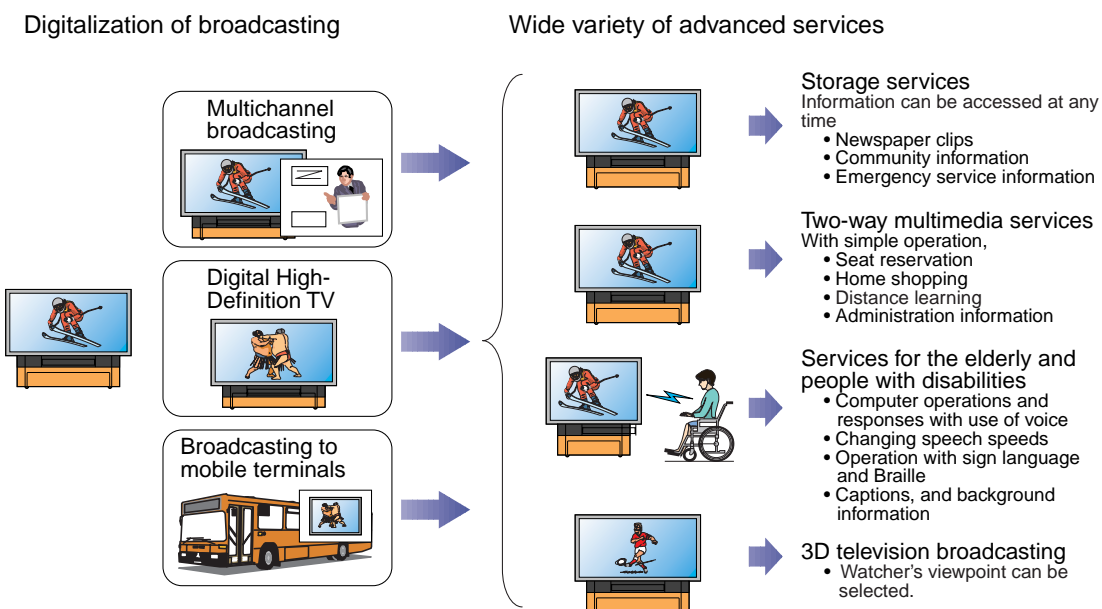

Fig. 2 Schedule for introduction of digital broadcasting

Year	1996	1997	1998	1999	2000 ~
<b>CS broadcasting</b>	PerfecTV		SKY PerfecTV!		
<b>BS broadcasting</b>		BS-4 No. 1 (analog)	Setting of technical requirements		BS-4 No. 2 planned for launch (digital)
<b>Cable TV</b>		Setting of technical requirements		Start of digital service	
<b>Terrestrial broadcasting</b>		Field trials		Setting of technical requirements	
		Holding of the Advisory Committee on Terrestrial Digital Broadcasting		Pilot trials	Ready to begin operations

Note: PerfecTV and Sky-B merged in May 1998 to form SKY Perfec TV !.

## (2) Digitalization of terrestrial broadcasting

**Target schedule is for test digital terrestrial broadcasting to begin in 2000, followed by full-scale broadcasting in 2003.**

In order to discuss ways to facilitate the introduction of digital terrestrial broadcasting in Japan, MPT hosted a series of meetings of the "Advisory Committee on Terrestrial Digital Broadcasting" from June 1997, and their findings were compiled into a final report in October 1998.

The report covered wide-ranging issues, such as the significance of digitalizing terrestrial broadcasting; the vision for the introduction of terrestrial broadcasting smooth transition from the viewers' standpoint; and the vision for digital broadcasting terminals and support measures to promote digital broadcasts and broadcasting systems.

The report proposes, in introducing digital terrestrial broadcasting, to realize two types of broadcasting service: 1) Digital terrestrial TV broadcasting, which delivers video images as well as sound and data; and 2) Digital terrestrial audio broadcasting, which provides sound as well as data.

Schedules for the introduction of these services are as follows.

### 1. Digital terrestrial TV broadcasting

With the aim of total shift from analog broadcasting to digital broadcasting at an earlier stage, the Advisory Committee's report suggests that nationwide introduction of terrestrial digital broadcasting at the main stations will be completed by the end of 2006. Specifically:

1) In the Kanto region, all main stations, except for

independent UHF stations, are to begin test digital broadcasting in 2000 and full-scale digital broadcasting by the end of 2003.

2) In the Kinki and Chukyo regions, all stations except for independent UHF stations are to begin full-scale digital broadcasting by the end of 2003.

3) Main stations in other regions, including independent UHF stations in the Kanto, Kinki and Chukyo regions, are expected to begin full-scale digital broadcasting by the end of 2006.

The report proposed that the year 2010 as a final target year of termination of the analog broadcasting on the assumption that a review is made every three years, taking into consideration the situation as to the diffusion of digital broadcasting in each region and suggests market entry of new broadcasters should be permitted basically after the termination of analog broadcasting. In general, the digital broadcasting business will be made open to new entrants only after analog broadcasting has been discontinued.

### 2. Digital terrestrial audio broadcasting

The report suggests digital terrestrial audio broadcasting should be introduced in addition to the existing AM and FM broadcasting services and expects digital audio broadcasting, including test broadcasts, will start from 2000 in regions where it is possible to allocate suitable frequencies.

**Fig. Schedule for the implementation of digital terrestrial broadcasting**

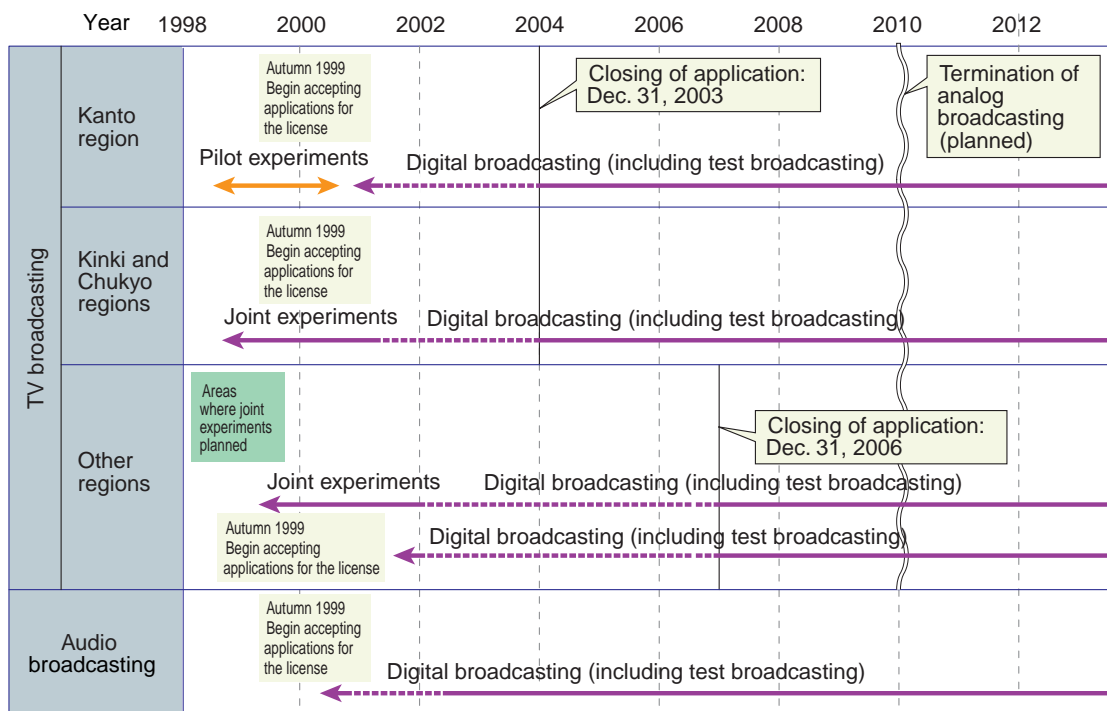



## (3) Technical trials for the introduction of digital terrestrial broadcasting

**Field trials are being conducted to ensure the successful launch of digital terrestrial broadcasting in Japan.**

With the goal of making digital terrestrial broadcasting the most widely used broadcasting medium in Japan, MPT is working hard to create the necessary legal frameworks, as well as to finalize such matters as the choice of digital broadcasting system and a channel allotment plan. Meanwhile, field trials are being conducted to ensure that digital terrestrial broadcasting will be launched smoothly.

### 1. Deciding which system to use

In order to investigate the technical feasibility of several digital broadcasting systems, the Association of Radio Industries and Businesses (ARIB) and other relevant organizations jointly conducted a series of indoor experiments and outdoor tests on basic transmission methods from January 1997 to September 1998. Based on the test results, the Telecommunications Technology Council decided upon a provisional digital terrestrial television broadcasting system in September 1998, and upon a provisional digital terrestrial sound broadcasting system in November 1998.

### 2. Channel allotment plan

MPT drafted a nationwide channel allotment plan for digital terrestrial broadcasting in December 1998, taking into consideration the results of research into radio wave propagation characteristics that began in fiscal 1997 in major cities throughout the country.

### 3. Field trials on digital terrestrial broadcasting systems

#### i) Functionality verification tests

To provide additional data for further discussion at the Telecommunications Technology Council on digital broadcasting systems, in November 1998 MPT began conducting functionality verification tests in field trials of the digital television broad-

casting system, referring to the results of the indoor experiments on the system. In May 1999, MPT also began large-scale verification tests of the provisionally chosen digital radio broadcasting system.

#### ii) Digital terrestrial broadcasting pilot experiments

In November 1998, MPT began conducting joint experiments with the "Tokyo Pilot," which consists of broadcasting companies, telecommunications carriers, manufacturers and others. This series of experiments, staged in the Kanto region, is intended to evaluate and verify the functionality of the provisional digital broadcasting systems in a real setting, as well as to check the functions and operation of digital broadcasting terminals.

The "Tokyo Pilot" has also been conducting experiments independently. In phase one of these, from November 1998, they carried out a range of image transmission experiments on such areas as multichannel broadcasting, HDTV broadcasting and program reception with mobile terminals. In phase two of the experiments, which began in April 1999, the committee has been conducting tests on such new services as data broadcasting, 3-D television and storage-type broadcasting.

### 4. Open facilities for R&D on digital terrestrial broadcasting

In fiscal 1998, MPT began a project to build facilities for research and development in 10 locations across Japan, which are leased to the researchers. Through the project, MPT aims to promote the earliest possible achievement of nationwide digital broadcasting, as well as to effectively help develop new technologies and services that are unique to various regions.

The project, under the management of the Telecommunications Advancement Organization of Japan, will link the 10 locations via broadcasting re-

lays, using relay equipment housed in the facilities. For about five years from fiscal 1999, the facilities will be made freely available to any researcher, with the aim of promoting a variety of projects that will utilize the characteristics of digital terrestrial broadcasting technologies.

**Fig. Outline of shared-use facilities for R&D on digital terrestrial broadcasting**

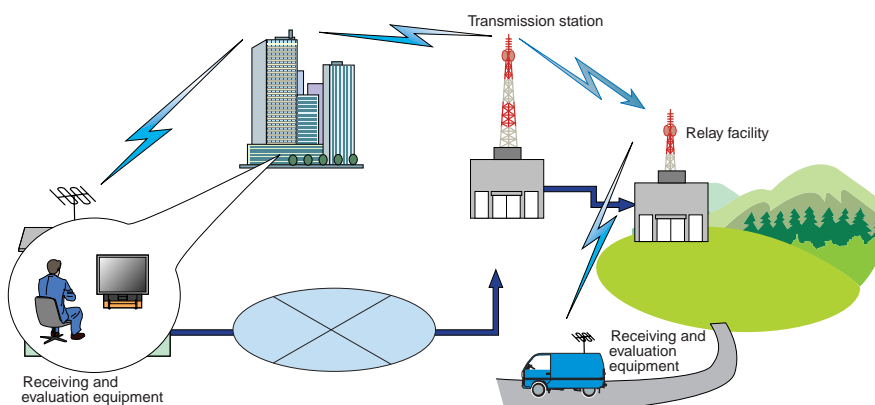

## (4) Digitalization of BS broadcasting

### BS digital broadcasting is planned for launch in 2000.

Broadcasting satellite (BS) digital broadcasting is planned for launch in 2000 via the second BS-4 satellite.

#### 1. Legal frameworks

To prepare for the introduction of BS digital broadcasting, MPT made the following revisions to relevant ministerial ordinances in June 1998, in line with the Radio Law and the Broadcast Law:

i) Set target numbers of channels in the Basic Plan for Broadcast Propagation, and compiling a Frequency Allocation Plan for Broadcasting Services.

The target number of channels for each broadcasting service has been set as follows:

- Simultaneous broadcasting, which simultaneously transmits the same program in both digital and analog formats → 5 channels
- HD (high-definition) TV broadcasting → 6 channels
- SD (standard-definition) TV broadcasting → approx. 20 channels
- Audio broadcasting → approx. 20 channels

ii) Application to BS digital broadcasting of the principle of excluding multiple ownership of mass media

The principle of excluding multiple ownership of

mass media has been extended to BS digital broadcasting. In terms of frequencies, each program-supplying broadcaster is allowed to use frequency resources up to a certain number of symbols per second. (A "symbol" is the smallest unit of information that can be transmitted simultaneously using a certain modulation method.) There are no restrictions on market entry by satellite broadcasters, but terrestrial broadcasters can enter the market only through another company in which they have less than a 33.3% stake.

iii) Setting of technical requirements for such radio facilities as BS digital broadcasting satellite stations, and formulation of standard transmission methods for BS digital broadcasting

#### 2. Program-supplying and facility-supplying broadcasters

Based on the program-supplying and facility-supplying broadcasters system introduced in May 1997, the Broadcasting Satellite System Corp. (BSAT) was chosen as the facility-supplying broadcaster in July 1998 and 10 program-supplying broadcasters were designated in October 1998.

For satellite data broadcasting, MPT plans to formulate technical requirements and appoint program-supplying broadcasters by the end of fiscal 1999.

Fig. Map of BS broadcasting channels

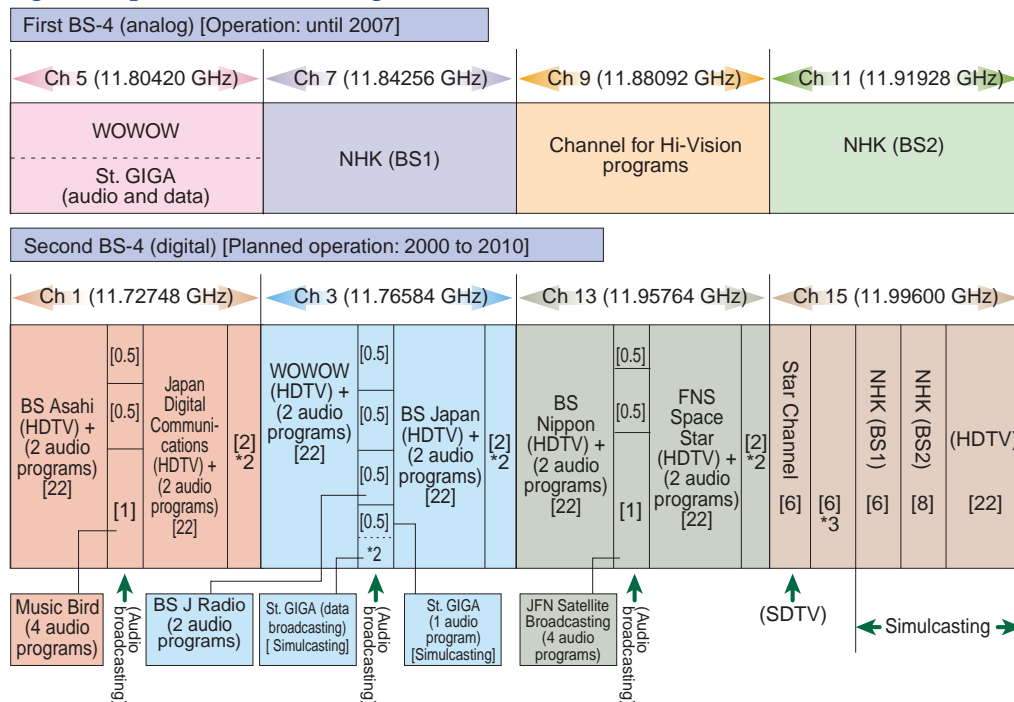

Notes: 1. Figures in [ ] are the number of slots assigned. There are 42 slots available in each transponder on the second BS-4 satellite. A slot is the smallest unit to which a certain modulation method can be applied.

2. Reserved for data broadcasting

3. Formerly assigned to WOWOW for simultaneous broadcasting

# (5) New satellite digital audio broadcasting

**2.6-GHz band satellite digital audio broadcasting is scheduled to begin in 2001.**

The 1992 World Radiocommunication Conference (WARC-92) decided to allocate frequencies in the 2.6-GHz band for satellite digital audio broadcasting in 12 countries, including Japan. In 1999, MPT will receive a report from the Telecommunications Technology Council regarding the broadcasting systems for 2.6-GHz band satellite digital audio broadcasting. Scheduled for launch in 2001, the service will broadcast, for the first time in Japan, programs to mobile terminals via satellite links. The new service enables:

- 1) mobile terminals to steadily receive broadcasting even when traveling at a high speed of 100 km/h, which is difficult with the conventional satellite broadcasting service;
- 2) uninterrupted program reception inside tunnels and behind buildings, by installing gap fillers (additional transmitters on the ground); and
- 3) the provision of multichannel broadcasting, combined with high-quality stereo sound, still images and simple animation.

**Fig. Outline of 2.6-GHz band satellite digital audio broadcasting**

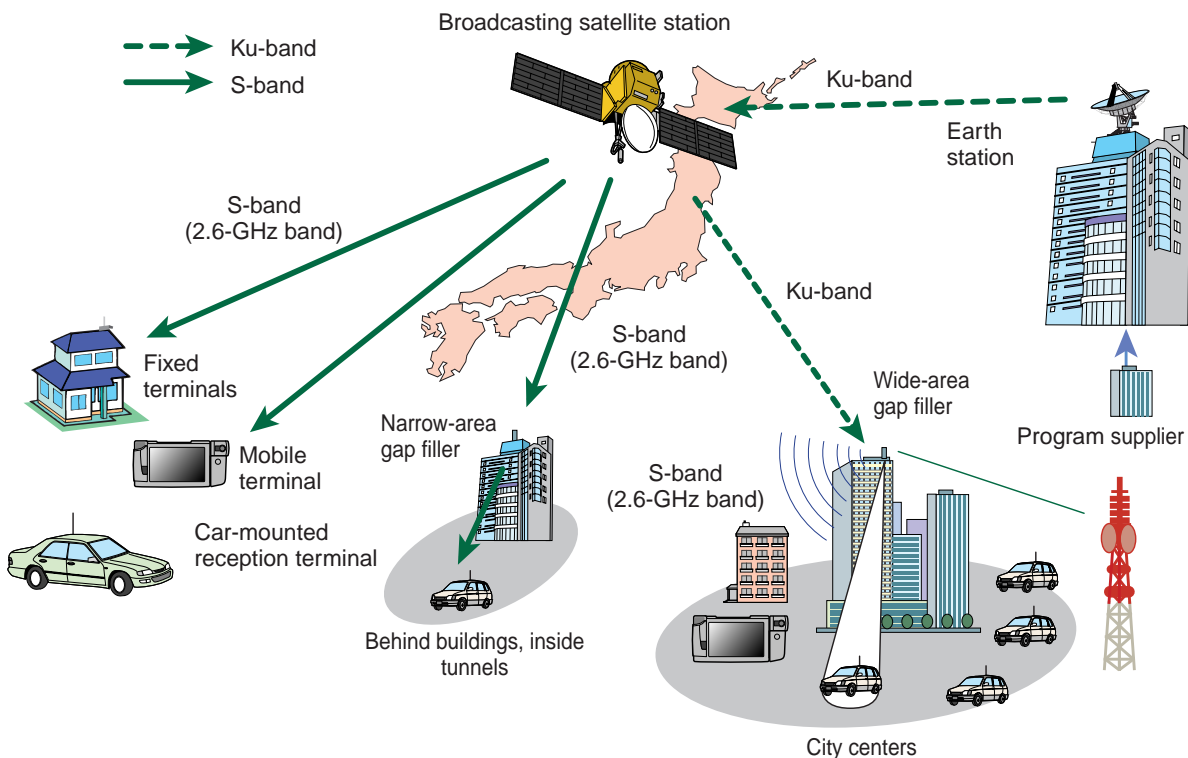

**Table Comparison of digital systems**

	Digital satellite audio broadcasting	Digital terrestrial audio broadcasting	BS digital broadcasting	CS digital broadcasting
Allocated frequencies	2.6 GHz band	VHF band	11.7 to 12.2 GHz	12.2 to 12.75 GHz
Receiving method	Mobile/fixed reception	Mobile/fixed reception	Fixed reception	Fixed reception
Types of receiving equipment	Car-mounted/portable	Car-mounted/pocket-sized	Fixed	Fixed
Main broadcasting services and coverage	High-quality sound, still images, simple animation (nationwide)	High-quality sound, still images, simple animation (regional)	HDTV, SDTV and high-quality sound (nationwide)	SDTV, and high-quality sound (nationwide)
Final version of the system	Planned for summer 1999	Planned for summer 1999	Decided	Decided

## (6) Digitalization of cable TV broadcasting

Digital cable TV broadcasting began in 1998.

### 1. Setting of technical requirements

In December 1996, MPT formulated the technical requirements for digital cable TV broadcasting, so as to:

- 1) enable retransmission of CS digital broadcast programming through cable TV networks (discussion is under way to also enable retransmission of BS digital broadcasting);
- 2) make conventional analog cable TV broadcasting equipment compatible with digital formats; and,
- 3) promote digital TV broadcasting businesses to operate worldwide, through using technical requirements that are comply with international standards.

These measures have increased the number of channels available, and enabled digital satellite broadcasting to be received without the need to use dedicated equipment, resulting in reduced costs for developing receiving devices.

In December 1997, MPT also established the "Study Group on Technological Support for the Diffusion of Digital Cable TV Broadcasting," whose job is to deliberate on technical issues in developing digital cable TV systems and in standardizing terminals. The study group compiled its final re-

port in March 1999.

### 2. Introduction of digital systems in cable TV

In the Kanto and Koshin'etsu regions, five operators began experimental digital cable TV broadcasting in May 1997. In July 1998, Kagoshima Cable Television Co., Ltd., based in Kagoshima City, became the first operator to launch full-scale digital cable TV broadcasting in Japan. At present, five cable TV stations plan to follow suit.

### 3. A wide variety of services can be made available through digitalization

Digitalization of cable TV broadcasting leads to dramatically increased transmission capacity and more stable transmission. Therefore, there is growing expectation for the wide range of interactive services that this can provide, such as communications, in addition to conventional TV programs. However, because cable TV subscribers have not yet fully benefited from these technological innovations, in October 1998 MPT asked the Telecommunications Council to consider measures to encourage the enhancement of cable TV broadcasting in Japan. In May 1999, the council compiled a report on its findings on measures to achieve that aim.

Fig. Outline of the digital cable TV broadcasting system

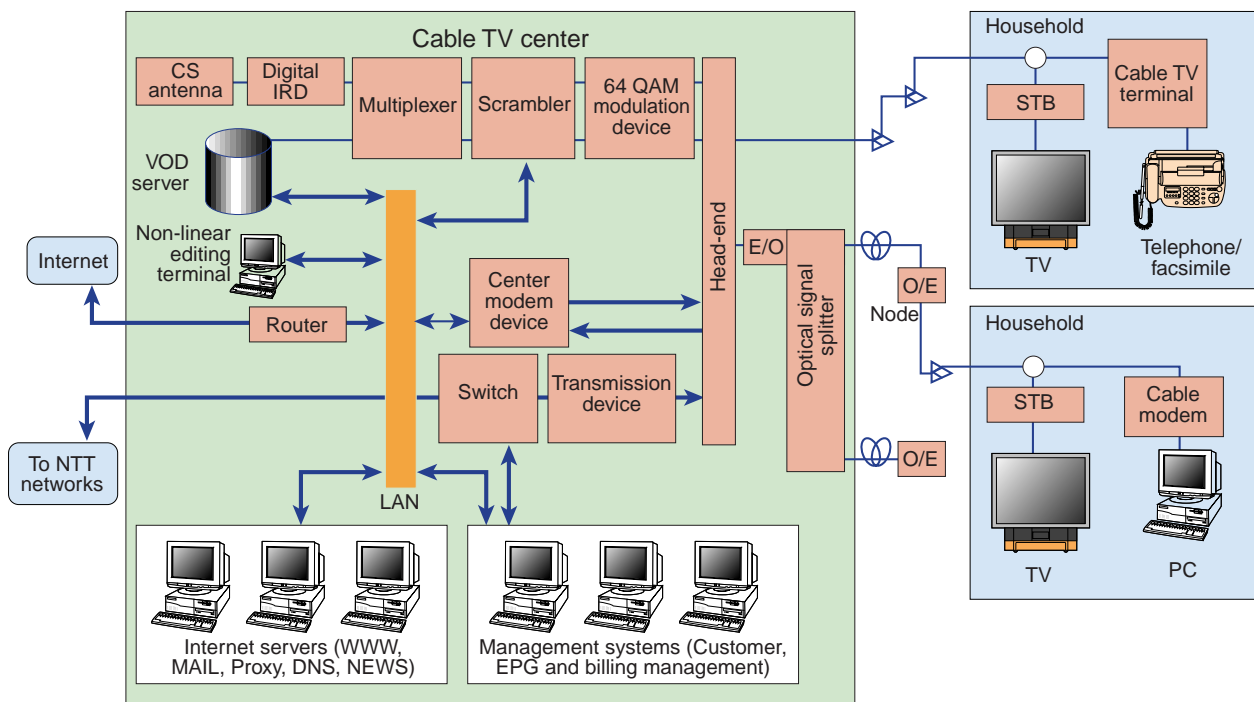

## (7) Digitalization of broadcast programming

### Digitalizing the process of broadcast program production, distribution and archiving

Recent developments in digital technology have led to an increase in the number of broadcast channels available. As a result, demand is growing for an environment in which new ways of program production, distribution and archiving can be carried out. In response, MPT is proceeding with a range of support measures for promoting the use of digital technology in these fields.

#### 1. Production

- i) R&D of fundamental technologies to produce broadcast programming by utilizing large-scale video archives

Since March 1999, efforts have been under way through the Telecommunications Advancement Organization of Japan (TAO) to research and develop fundamental technologies that enable joint program production through networks, linking several distant locations.

- ii) R&D on advanced systems to produce intelligent content for digital broadcasting

To promote the use of digital technologies in program production, MPT began a research and development project from March 1999, entrusting its management to TAO. The project, part of a program for the "Development of Creative Communications and Broadcasting Systems," is aimed at promoting systems of content production that use such new methods as high-resolution image and multi-story contexts.

- iii) Financial support for the digitalization of facilities  
In order to support ongoing efforts to digitalize

program production facilities, MPT implemented a range of financial support measures during fiscal 1998. Among them were a tax incentive implemented for one year from June 1998 to May 1999, and loan systems financed by the Japan Development Bank (JDB) and other financial institutions (Refer to Appendices 41 and 42).

In fiscal 1999, as part of its program to promote the digitalization of terrestrial broadcasting, MPT is offering financial support measures for the building of facilities for digital program production and digital transmission, through tax incentives, as well as loan systems financed by the JDB and others. In addition, MPT submitted its "Advanced Television Broadcasting Facility Development Promotion Temporary Measures Bill" to the 145th Ordinary Diet session, aiming to establish a financial support system, with loans guaranteed by TAO.

#### 2. Distribution

From fiscal 1999, MPT will develop a database, and its management system, to enable effective access to information about the distribution of broadcast programming.

#### 3. Digital archives

Since March 1999, MPT has been promoting the development of systems that enable the sharing of program databases, commissioning TAO with its management. TAO will expand the databases, digitalize the stored programs and link video libraries via networks, by which users can search for programs and watch them.

Fig. Outline of digitalization of broadcast programming

